



F9-480 Series 4/8/16E1 Plus Ethernet
Multi-service Multiplexer User Manual

(Version 2.1)

Beijing Fibridge Co., Ltd

Table of Content

1. Overview	3
2. Features	3
2.1. Hardware Features	3
2.2. Software Features.....	4
3. Typical Application.....	5
3.1. Point to Point Topology	5
3.2. Star Topology	6
4. Specification.....	6
4.1. Optical Port	6
4.2. E1 Port.....	7
4.3. Ethernet Port.....	7
4.4. Phone Port.....	7
4.5. Data Port.....	7
4.6. Management Port	8
4.7. Power Supply.....	8
4.8. Operating Environment	9
4.9. Device Size	9
5. Device Panel.....	9
5.1. 4/8E1 Multi-service Multiplexer, Standalone	9
5.2. 16E1 Multi-service Multiplexer	13
5.3. Chassis of E1 Multi-service Multiplexer	18
5.4. 2*4E1 Multi-service Multiplexer Module	19
5.5. 4/8E1 Multi-service Multiplexer Module	21
5.6. EOW Module.....	23
5.7. POW Module.....	27

6. Installation & Maintenance	28
6.1. Install the Module and Chassis	28
6.2. Install the Standalone device	29
6.3. Using Phone	30
6.4. Maintenance	31
7. Order Information.....	31
7.1. Model	31
7.2. Part Number(P/N) of the standalone	32
7.3. Part Number(P/N) of the Module.....	33
7.4. Part Number(P/N) of the Chassis.....	34

1. Overview

Multi-service Multiplexer combines digital multiplexing chip and optical transmission technology. It is suitable for low capacity, point-to-point application of remote transmission. The circuit part of the equipment is fully digitized. The whole equipment is reliable, stable, easy to install and maintain. It has good temperature and voltage characteristics, complete alarm functions, one RS232/485 asynchronous interface and remote branch loop back functions. At the same time, it can be monitored from Fi-View-MP management software.

First of all, Multi-service Multiplexer can multiplex E1 (Up to 16E1) and Ethernet (2*10/100Mbps) signals in one fiber channel to transmit. It is widely used in voice and data application field.

Sometimes, we use **Multiplexer** instead of **Multi-service Multiplexer**. They have the same meaning.

2. Features

2.1. Hardware Features

- Providing up to 16 E1 channels and two optional 10/100Mbps Ethernet channels
- Double Optical ports optional for redundant backup, auto-alternative
- With special optical module, the device can support ALS

(Automatic Laser Shutdown) function

- E1 Line code: HDB3, compliant to G.703, G.823 and G.742.
- Both the two Ethernet ports support 10/100Mbps auto-detection, Full/Half Duplex auto-negotiation
- Ethernet ports support VLAN and flow control
- Complete alarm functions
- Providing an RS232 /RS485 asynchronous interface
- Supporting the local/remote E1 loop back
- Remote branch loop back provided by software and hardware
- Providing RS232 and Ethernet port for management
- Standalone and chassis optional, 220VAC and -48VDC optional

2.2. Software Features

- Support local and remote management
- Support Console, WEB and SNMP management
- RS-232 DB9 male management port and 10/100Mbps RJ45 Ethernet management port available
- Show details of system information, including chassis name, location information, IP address, start-up time, software and hardware version
- View & configure the working status of local and remote device, including connection status, speed, half/full duplex mode, port status
- Support remote loop back function, helping to find out the line fault conveniently
- A float window available for real-time alarm messages. And all alarm messages can pop up to get more attention

- Reset the system or a single local module or remote end device via management software
- Reset chassis to factory default
- Show the detailed information of power supply, including AC/DC type and running status
- Support firmware updating, with the update tool and new version firmware file download from our website.
- Provide MIB file, make it easy to be integrated into the third-party SNMP management software
- Adopt the centralized management style and the tree-view catalogue, which can manage many sets of chassis at the same time in one single window. Meantime, it's very easy and clear to manage all devices even if many chassis in one window.

3. Typical Application

3.1. Point to Point Topology

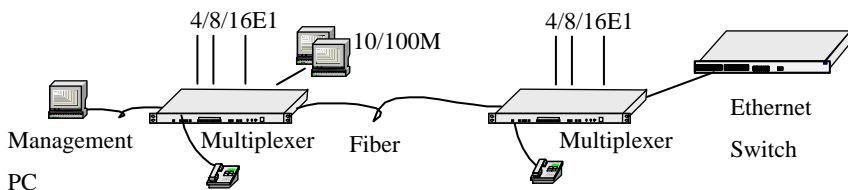
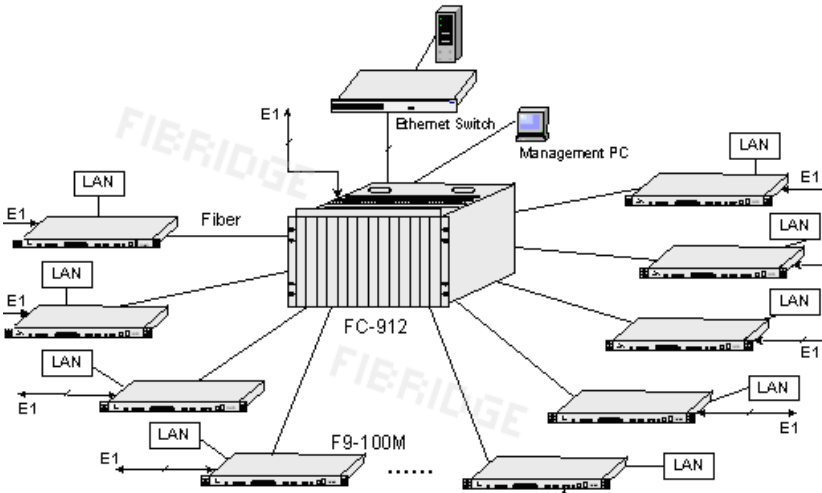

Figure1 Point to Point Topology

3.2. Star Topology



F9-100M represents standalone of the Multi-service Multiplexer

Figure2 Star Topology

4. Specification

4.1. Optical Port

- Bit rate: 150Mb/s+/-50ppm
- Wavelength: 1310nm/1550nm
- Output power: -11 to -4dBm
- Sensitivity: better than -36dBm
- Connector: FC/SC/ST
- Redundant backup optical port optional
- Auto Laser shutdown (ALS) Optional

Beijing FibrIDGE Co., Ltd.

Tel: +8610-58858988 Fax: +8610-58858520 <http://www.fibridge.com>

4.2. E1 Port

- Data rate: 2048Kbps
- Code type: HDB3
- Compliant with G.703, G.704
- Impedance: 75 Ω (Unbalanced), 120ohm (Balanced) optional
- Connector: BNC(75 Ω), RJ45(120ohm)
- Jitter: Compliant with ITU-T G.742 and G.823
- Unframed mode
- Numbers: 4/8/16 optional

4.3. Ethernet Port

- Compatible with IEEE802.3, IEEE802.3u
- Speed: 10/100Mbps
- Full/Half duplex auto negotiating
- Connectors: RJ-45
- MDI/MDI-x auto negotiating
- Ethernet port: 2 ports

4.4. Phone Port

- Available for daily telephone communication
- 64Kbps PCM Code
- When picking up the local side, the remote side rings.
- One side hung up, the other side sounds busy.

4.5. Data Port

- RS232/RS485 Protocol

- For RS232, Bit rate: 4.8Kbps-115.2Kbps
- Connector: DB9, male, check table1 for the definition

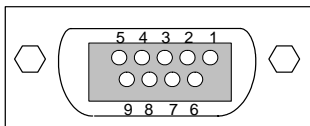

Table1 Definition of the Data DB9

PIN	2	3	5	1, 4	6	7	8	9
Protocol	RS232				RS485			
Definition	RX	TX	GND	N.A.	TX- (Z)	TX+ (Y)	RX- (B)	RX+ (A)

4.6. Management Port

- Type: Console management
- Protocol: RS232, bit rate 9600bps or 19200bps
- Connector: DB9, male, check table2 for the definition

Table2 Definition of the Management DB9

PIN	2	3	5	Others
Definition	RX	TX	GND	N.A.

4.7. Power Supply

- Input voltage:
AC: 100V ~ 240V, 50/60Hz
DC: -48V
- Power Consumption : 5W

4.8. Operating Environment

- Temperature: 0°C—50°C
- Humidity: 95%, no condensing

4.9. Device Size

- 4/8E1 Standalone device
434mm (W) × 44mm (H) × 200mm (D)
- 16E1 Standalone device
434mm (W) × 44mm (H) × 234mm (D)
- Chassis size
19 inch (W) × 6U (H) × 300mm (D)

5. Device Panel

5.1. 4/8E1 Multi-service Multiplexer, Standalone

5.1.1. Front Panel of 4/8E1 Multi-service Multiplexer

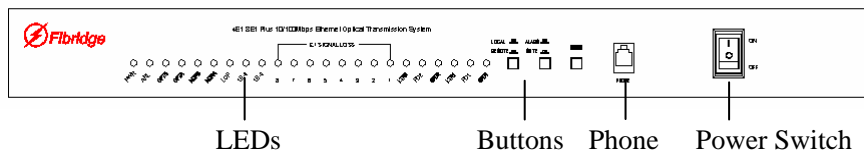

Figure3 Front Panel of the 4/8E1 Multiplexer standalone

5.1.2. Back Panel of 4/8E1 Multi-service Multiplexer

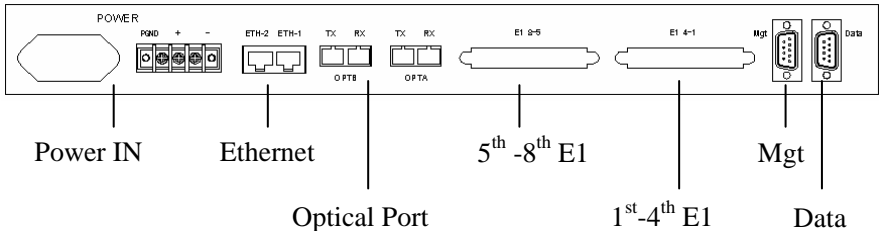

Figure4 Back Panel of the 4/8E1 Multiplexer standalone

5.1.3. LEDs Description of 4/8E1 Multi-service Multiplexer

Talbe3: LEDs description of the 4/8E1 Multiplexer standalone

LEDs	Color	Stat.	Description
PWR	Green	ON	Power Supply OK
ARL	Red	ON/ Blink	ARL is on When local device has any alarm. ARL blinks when remote device has alarm but no alarm at local device.
OPTB	Green	ON	Optical-B work state indicator. OPTB is on when Optical-B works.
OPTA	Green	ON	Optical-A work state indicator. OPTA is on when Optical-A works.
NOPB	Red	ON	NOPB is on when no optical signals is detected by RX of Optical-B Port.
NOPA	Red	ON	NOPA is on when no optical signals is detected by RX of Optical-A Port.

LOF	Red	ON	LOF is on when Optical Line loses synchronization. IE-3 and IE-6 Alarm are masked when LOF alarm occurs.
IE-3	Red	ON	1E-3 is on when optical line's bit error rate is over 10^{-3} .
IE-6	Red	ON	1E-6 is on when optical line's bit error rate is over 10^{-6} .
LOS8- LOS1	Red	ON	LOSx (x=1~8) is on When the relevant E1 Channel Signal loses.
LTR2	Green	ON/ Blink	Ethernet2 Link/TX/RX indicator. LTR2 is on when the Ethernet2 port of the local device links properly, LTR2 blinks when the Ethernet2 port of the local device is transmitting or receiving Data.
FD2	Green	ON	Ethernet2 Half/Full Duplex status indicator. FD2 is on when the Ethernet2 port of the local device is working at Full Duplex.
BT2	Green	ON	Ethernet2 10M/100M bps speed indicator. BT2 is on when the Ethernet2 port of the local device is working at 100Mbps speed.
LTR1	Green	ON/ Blink	Ethernet1 Link/TX/RX indicator. LTR1 is on when the Ethernet1 port of the local device links properly, LTR 1blinks when the Ethernet1 port of the local device is transmitting or receiving data.
FD1	Green	ON	Ethernet1 Half/Full Duplex status indicator. FD1 is on when the Ethernet1 port of the local device is working at Full Duplex.
BT1	Green	ON	Ethernet1 10M/100M bps speed indicator. BT1 is on when the Ethernet1 port of the local device is

Beijing FibrIDGE Co., Ltd.









 Tel: +8610-58858988 Fax: +8610-58858520 <http://www.fibridge.com>

			working at 100Mbps speed.
--	--	--	---------------------------

Note: The LOF/1E-3/1E-6/LOS/LTR/SPD/FDX LEDs are corresponding to the status of the remote device if the local/remote button is pressed down.

5.1.4. Button Description of 4/8E1 Multi-service Multiplexer

Table4 Panel Button Description of 4/8E1 Multiplexer

Type/Status		Description
LOCAL/ REMOTE	LOCAL 	When the button of 'Local/Remote' is pressed down as  , this led shows the status of remote device. Opposite, when up as  , the led shows the status of local device.
	REMOTE 	
ALARM/ MUTE	ALARM 	When the button of 'Alarm/Mute' is pressed down as  , the alarm sound is mute. Opposite, when up as  , the device sounds when any of the alarms occurs.
	MUTE 	
MASK	Switch Button	When press this button once, any of the current E1 LOS Alarm will be masked, it looks disappear. But new E1 LOS Alarm will still make the relevant LOS LED on.

5.1.5. Interface Description of 4/8E1 Multi-service Multiplexer

Table5 Interface Description of 4/8E1 Multiplexer

Ports	Description
PHONE	Phone Connector

POWER	AC/DC Power Input
ETH-2	The 2 nd Ethernet port, RJ45, 10/100Mbps, Half/Full Duplex
EHT-1	The 1 st Ethernet port, RJ45, 10/100Mbps, Half/Full Duplex
OPTB	Optical B, for backup function
OPTA	Optical A
E1 8-5	5 th ~8 th E1 Channel, DB37 Connector, connected by an adapter
E1 4-1	1 st ~4 th E1 Channel, DB37 Connector, connected by an adapter
Mgt	Management Console port, RS232, DB9 Connector
Data	RS232/RS485 Data port, DB9 Connector

Note: Above description is include all the ports. The ordered device maybe haven't some of the ports, such as optical B, 5th~8th E1 channel, etc.

5.2. 16E1 Multi-service Multiplexer

5.2.1. Front Panel of 16E1 Multi-service Multiplexer

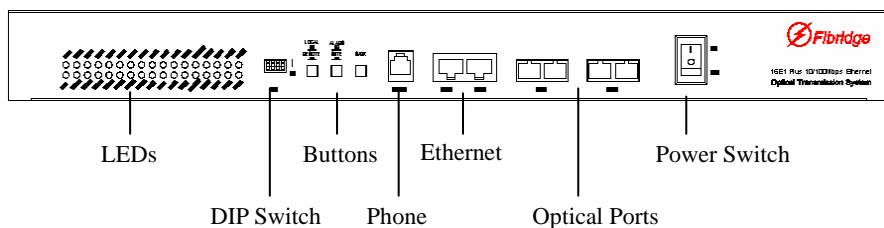

Figure5 Front Panel of the 16E1 Multiplexer standalone

5.2.2. Back Panel of 16E1 Multiplexer

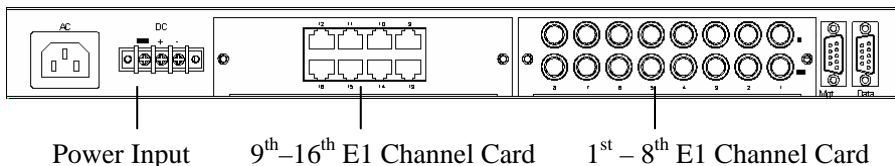

Figure6 Back Panel of the 16E1 Multiplexer standalone

Note: There are two types of Modules for the E1 channel. One is 8*BNC Module for 75ohm impedance, the other is 8*RJ45 Module for 120ohm impedance. They are exchangeable.

5.2.3. LEDs of 16E1 Multi-service Multiplexer Description

Table6: LEDs Description of the 16E1 Multiplexer

LEDs	Color	Stat.	Description
PWR	Green	ON	Power Supply OK
ARL	Red	ON/ Blink	ARL is on When local device has any alarm. ARL blinks when remote device has alarm but no alarm at local device.
LOS16- LOS1	Red	ON	LOSx (x=1~16) is on When the relevant E1 Channel Signal loses.
LTR1	Yellow	ON/ Blink	Ethernet1 Link/TX/RX indicator. LTR1 is on when the Ethernet1 port of the local device links properly, LTR 1blinks when the Ethernet1 port of the local device acts, that is, transmitting or receiving.

LTR2	Yellow	ON/ Blink	Ethernet2 Link/TX/RX indicator. LTR2 is on when the Ethernet2 port of the local device links properly, LTR2 blinks when the Ethernet2 port of the local device acts, that is, transmitting or receiving.
SPD1	Green	ON	Ethernet1 10M/100M bps speed indicator. BT1 is on when the Ethernet1 port of the local device is working at 100Mbps speed.
SPD2	Green	ON	Ethernet2 10M/100M bps speed indicator. BT2 is on when the Ethernet2 port of the local device is working at 100Mbps speed.
FDX1	Green	ON	Ethernet1 Half/Full Duplex status indicator. FD1 is on when the Ethernet1 port of the local device is working at Full Duplex.
FDX2	Green	ON	Ethernet2 Half/Full Duplex status indicator. FD2 is on when the Ethernet2 port of the local device is working at Full Duplex.
WORKA	Green	ON	Optical-A work state indicator. OPTA is on when Optical-A works.
WORKB	Green	ON	Optical-B work state indicator. OPTB is on when Optical-B works.
NOPA	Red	ON	NOPA is on when no optical signals is detected by RX of Optical-A Port.
NOPB	Red	ON	NOPB is on when no optical signals is detected by RX of Optical-B Port.
LOFA	Red	ON	LOFA is on when Optical-A Line loses synchronization. IE-3 and IE-6 Alarm are

			masked when LOFA alarm occurs.
LOFB	Red	ON	LOFB is on when Optical-B Line loses synchronization. IE-3 and IE-6 Alarm are masked when LOFB alarm occurs.
IE-3A	Red	ON	1E-3A is on when optical-A line's bit error rate is over 10-3.
IE-3B	Red	ON	1E-3B is on when optical-B line's bit error rate is over 10-3.
IE-6A	Red	ON	1E-6A is on when optical-A line's bit error rate is over 10-6.
IE-6B	Red	ON	1E-6B is on when optical-B line's bit error rate is over 10-6.

Note: The **Work / NOP / LOF / 1E-3 / 1E-6 / LOS / LTR / SPD / FDX** LEDs will show the status of the remote device if the local/remote button is pressed down.

5.2.4. DIP Switch SET of 16E1 Multi-service Multiplexer









Table7 DIP Switch Description of the 16E1 Multiplexer

Bit1,2	Optical port Selection	X ON	ON OFF	OFF OFF
		Forced Port A	Forced Port B	A/B Auto-select
Bit3	E1Loop back	ON: Local loop enable, OFF: Remote loop enable		
Bit4	ALS setting	ON: ALS Enable, OFF: ALS Disable		

Note: X means both ON and OFF are OK.

5.2.5. Button Description of 16E1 Multi-service Multiplexer

Table8: Description for the Button of 16E1 Multiplexer

Type/Status		Description
LOCAL/ REMOTE	LOCAL 	When pressed down as  , this led shows the status of remote device. When Pressed up as  , the led shows the status of local device.
	REMOTE 	
ALARM/ MUTE	ALARM 	When pressed down as  , the alarm sound is mute. When pressed up as  , the device sounds when any of the alarms occurs.
	MUTE 	
MASK	Switch Button	When press this button once, any of the current E1 LOS Alarm will be masked, it looks disappear. But new E1 LOS Alarm will still make the relevant LOS LED on.

5.2.6. Interface Description of 16E1 Multi-service Multiplexer

Table9 Interface Description of 16E1 Multiplexer

Port	Description
PHONE	Phone Connector
ETH-2	The 2 nd Ethernet port, RJ45, 10/100Mbps, Half/Full Duplex
EHT-1	The 1 st Ethernet port, RJ45, 10/100Mbps, Half/Full Duplex
OPTB	Optical B, for backup function

Beijing Fibrbridge Co., Ltd.

 Tel: +8610-58858988 Fax: +8610-58858520 <http://www.fibrbridge.com>

OPTA	Optical A
Power	AC/DC Power Input
E1 16-9	One card which can be installed into the standalone box, 75ohm/120ohm Optional
E1 8-1	
Mgt	Management Console port, RS232, DB9 Connector
Data	RS232/RS485 Data port, DB9 Connector

Note: Above description is include all the ports. The ordered device maybe haven't some of the ports, such as optical B, ETH1& ETH2 etc.

5.3. Chassis of E1 Multi-service Multiplexer

5.3.1. Front View of the Chassis

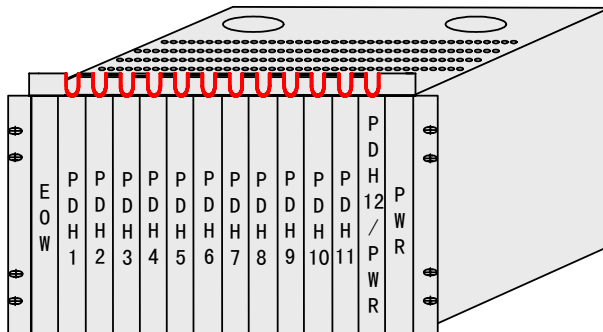

Figure7: Slots types distributing

As shown in the above figure, there are 14 slots chassis in the device. These 14 slots are dividing into three parts: the leftmost slot

is for EOW, the rightmost slot is for 220VAC PWR, the other 12 slots is for Multi-service Multiplexer Module. The 12th Multi-service Multiplexer Module can also be installed for 220VAC PWR Module.

For -48VDC power input, user needn't install any Power Module. User only need to connect the -48V power input connector to the -48VDC power source.

5.3.2. Back View of the Chassis

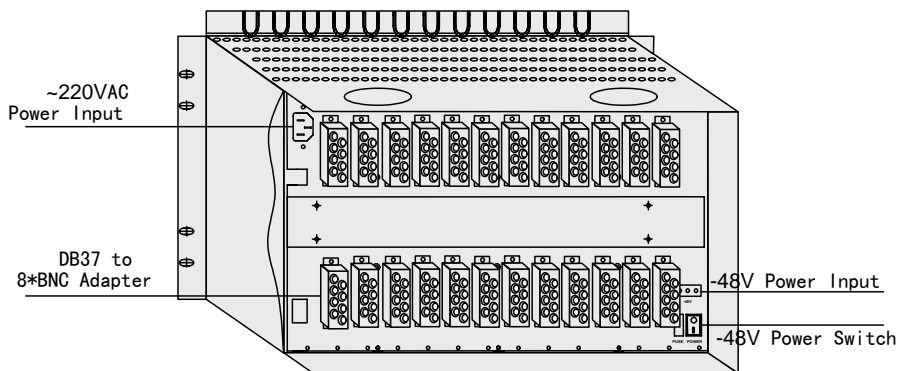

Figure8: Back Panel View of the Chassis

5.4. 2*4E1 Multi-service Multiplexer Module

For 2*4E1 Multi-service Multiplexer Module, one module has two independent 4E1 Multi-service Multiplexer device. They are the same. The two optical port is independent.

5.4.1. Panel sketch map of the 2*4E1 Multi-service Multiplexer

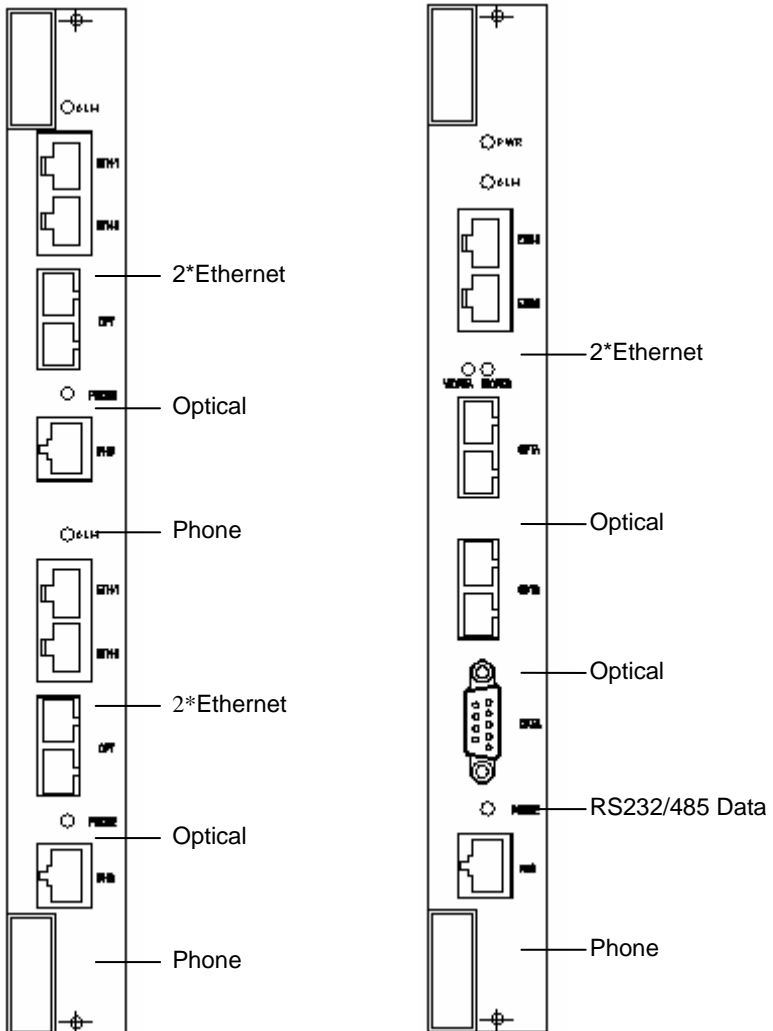

Figure9 The Panel of the 2*4E1 (Left) and 8E1 Multiplexer Module

5.4.2. LEDs Description of the 2*4E1 Module

Table10 LEDs Description of 2*4E1 Multiplexer Module

LEDs	Color	Status	Description
ARL	Red	ON/ Blink	ARL is on When local device has any alarm. ARL blinks when remote device has alarm but no alarm at local device. When button of 'Local/Remote' is pressed down, this led shows the ALARM status of remote device.
PHONE	Green	ON/ Blink	PHONE blinks When one calling but haven't been talking. PHONE is on When talking.

5.4.3. User Interface of the 2*4E1 Module

Table11 User interface description of the 2*4E1 Module

接口	含义
ETH1	The 1 st Ethernet port, RJ45, 10/100Mbps, Half/Full Duplex
ETH2	The 2 nd Ethernet port, RJ45, 10/100Mbps, Half/Full Duplex
OPT	Optical port
PHS	For phone, use one MDI-UTP to connect to the EOW Module

5.5. 4/8E1 Multi-service Multiplexer Module

For 1*4E1 or 8E1 Multi-service Multiplexer Module, one module has only one independent 4E1 or 8E1 Multiplexer device. The second optional optical port is for redundant backup.

5.5.1. Panel of the 4/8E1 Multi-service Multiplexer Module

Please see **Figure9** to get the detail information.

5.5.2. LEDs Description of the 4/8E1 Multiplexer Module

Table12: LEDs Description of the 4/8E1 Multiplexer Module

LEDs	Color	Status	Description
PWR	Green	ON	Power work state indicator. PWR is ON when Power supply ok.
ARL	Red	ON/ Blink	ARL is ON When local device has any alarm. ARL blinks when remote device has alarm but no alarm at local device. When button of 'Local/Remote' is pressed down, this led shows the ALARM status of remote device.
WORKA	Green	ON	Optical-A work state indicator. WORKB is ON when Optical-B works.
WORKB	Green	ON	Optical-B work state indicator. WORKA is ON when Optical-A works.
PHONE	Green	ON/ Blink	PHONE is ON When calling. PHONE blinks When local device be called by the remote end device or local device call the remote end device.

5.5.3. User Interface of the 4/8E1 Multiplexer Module

Table13 Interface Description of the 4/8E1 Multiplexer Module

Port	Description
ETH1	The 1 st Ethernet port, RJ45, 10/100Mbps, Half/Full Duplex
ETH2	The 2 nd Ethernet port, RJ45, 10/100Mbps, Half/Full Duplex
OPTA	Optical A
OPTB	Optical B for redundant backup
DATA	RS232/RS485 are Both OK, DB9 connector
PHS	For phone, use one MDI-UTP to connect to the EOW Module

5.6. EOW Module

EOW Module provides two main functions. One is for giving the Phone connected channel, the other is for Management. The EOW Module supports two kinds of management port. One is RS232, which gives Console management. The other is Ethernet, which gives SNMP-based management.

For more information about the management, please check relative software user manual.

5.6.1. Panel sketch map of the EOW Module

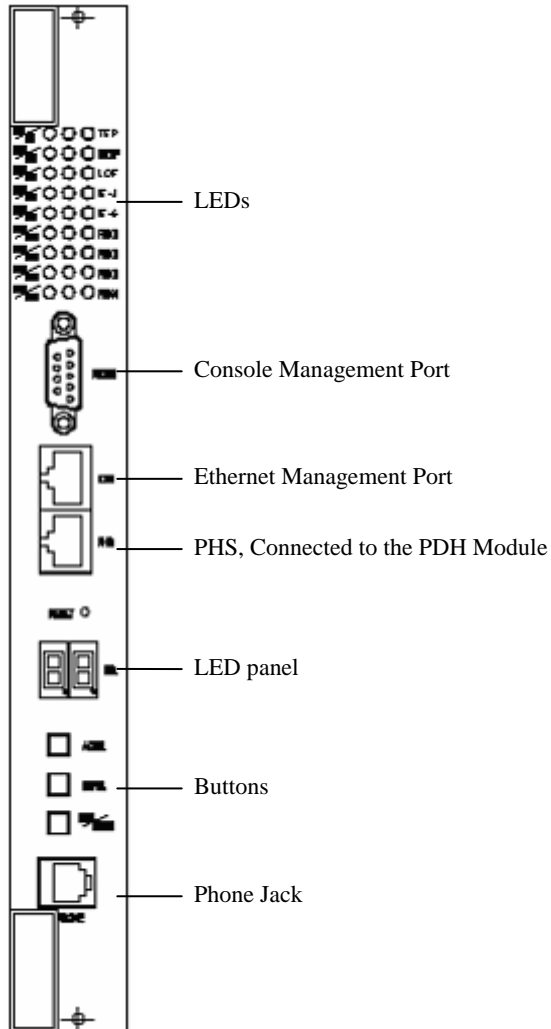

Figure10 The Panel map of the EOW Module

5.6.2. LEDs of the EOW Module

Table14 LEDs description of the EOW Module

LEDs	Color	Status	Description
PWR	Green	ON	Power work state indicator. PWR is ON when Power supply ok.
ACT	Yellow	ON	EOW work state indicator. ACT blinks when EOW Module works properly.
TMP	Red	ON	Temperature alarm indicator. TMP is ON When temperature of slots chassis is over 70 °C
LOS1- LOS8	Red	ON	LOSx (x=1~8) is ON When the relevant E1 Channel Signal loses.
NOP	Red	ON	NOP is ON when no optical signals is detected by RX of Optical Port.
LOF	Red	ON	LOF is ON when Optical Line loses synchronization. IE-3 and IE-6 Alarm are masked when LOF alarm occurs.
IE-3	Red	ON	IE-3 is ON when optical line's bit error rate is over 10^{-3} .
IE-6	Red	ON	IE-6 is ON when optical line's bit error rate is over 10^{-6} .
LTR1- LTR4	Yellow	ON/ Blink	Ethernet x (x=1~4) Link/TX/RX indicator. LTR x (x=1~4) is ON when the Ethernet port of the local device links properly, LTR x (x=1~4) blinks when the Ethernet1 port of the local device is transmitting or receiving data.

FD1- FD4	Green	ON	Ethernet x(x=1~4) Half/Full Duplex status indicator. FD x (x=1~4) is ON when the Ethernet port of the local device is working at Full Duplex.
SPD1- SPD4	Green	ON	Ethernet x (x=1~4) 10M/100M bps speed indicator. BT x (x=1~4) is ON when the Ethernet port of the local device is working at 100Mbps speed.

Note: 1) LOS, NOP, LOF, 1E-3, 1E-6, LTR, FD, SPD LEDS shows the status of the Multi-service Multiplexer Module, the Number of which is appeared on the LED Panel.

2) For 2-port-Ethernet Multi-service Multiplexer Module, LTR3-4, FD3-4, SPD3-4 is not available.

3) The NOP/LOF/1E-3/1E-6/LOS/LTR/SPD/FDX LEDs will show the status of the remote device if the local/remote button is pressed down.





5.6.3. User Interface of the EOW Module

Table15 User Interface Description of the EOW

Ports	Description
RS232	DB9, RS232 port for Console Management
ETH	RJ45, Ethernet Port for WEB/SNMP-based Management Support 10/100M, Full/Half Duplex automation.
PHS	RJ45, Used to connect to the Multi-service Multiplexer Module to use the PHONE
PHONE	RJ11, Telephone port. Connect common telephone.
NO.	LED Panel, showing the Address of the relative Multi-service Multiplexer Module

5.6.4. Button of the EOW Module

Table16 Button Description of the EOW

Button	Description
RESET	Reset Button. Restart the EOW firmware.
ADDR	Multi-service Multiplexer Module addresses select. The Address is added by one when pressing.
MUTE	When the button of 'MUTE' is pressed down as  , the alarm sound is mute. Opposite, when up as  , the device sounds when any of the alarms occurs.
LOCAL /REMOT	When the button of 'Local/Remote' is pressed down as  , this led shows the status of remote device. Opposite, when up as  , the led shows the status of local device.

5.7. POW Module

The POW Module is used only when the user use 220VAC Power Input Source. When the user uses -48VDC Power Input Source, the Power Module is not needed, for each Multi-service Multiplexer Module has the circuit to converter -48VDC to 5VDC.

There are two kinds of POW Module. One is 75W, the other is 120W. Only for 75W POW Module, the chassis supports Power Backup, for the 120W POW Module needs 2 slots. Commonly, the 75W POW Module is enough.

6. Installation & Maintenance

6.1. Install the Module and Chassis

- Open the package, check the device and the attachment, contradistinguish to the Packing List;
- Install the Module, such as EOW, POW, Multi-service Multiplexer Module, to the Chassis;
- Connect the ports to other proper device. For example, connect the management port to the PC or the switch, connect the E1 port to PBX, etc.
- Connect the Power input to the proper power source. **NOTE, -48VDC and 220VAC can't be used at the same time!**
- Fasten the device to the proper place;
- Power ON. Please check whether any unexpected LEDs (esp. RED LEDs) are ON. However, the E1 LOS will be ON when the E1 channel is not connected, and this will cause the general alarm 'ARL' red LED on the Multi-service Multiplexer Module becoming ON.
- User can check the LEDs one the EOW to see the detail status of the Multi-service Multiplexer Module. To do this, user should first push the 'ADDR' button on the EOW Module to get the right Address of the expected Multi-service Multiplexer Module. Please refer to the below figure to get the actual address of every Multi-service Multiplexer module.

E O W	01	03	05	07	09	11	13	15	17	19	21	23	P W R
	02	04	06	08	10	12	14	16	18	20	22	24	

↑

Part A

↓

Part B

The addresses of Both Part A and Part B are available for the 2*4E1 Multi-service Multiplexer Module. For 1*4E1 Multi-service Multiplexer Module or 1*8E1 Multi-service Multiplexer Module, only the address of the Part A is available.

6.2. Install the Standalone device

- Open the package, check the device and the attachment, contradistinguish to the Packing List;
- Connect the ports to other proper device. For example, connect the Ethernet port to the PC or the switch, connect the E1 port to PBX, etc.
- Connect the Power input to the proper power source. **NOTE, -48VDC and 220VAC can't be used at the same time!**
- Fasten the device to the proper place;
- Power ON. Please check whether any unexpected LEDs (esp. RED LEDs) are ON. However, the E1 LOS will be ON when the E1 channel is not connected, and this will cause the general alarm 'ARL' red LED becoming ON.

6.3. Using Phone

6.3.1. From standalone to standalone

- Connect Phone to the Multi-service Multiplexer device.
- Pick up one phone, the other end phone will ring.
- Pick up the other phone handle, talking
- Busy sound will be sent when one hangs up the phone

6.3.2. From standalone to the Chassis

- Connect phone to the **PHONE** jack of the standalone and the EOW of the chassis
- Pick up the phone of the standalone
- On the Chassis end, sounds appear, and the PHONE led of the relative Multi-service Multiplexer Module blinks.
- Use one UTP to connect the PHS jack between the EOW and the relative Multi-service Multiplexer Module
- Pick up the phone connected to the EOW, talking
- Busy sound will be sent when one hang up the phone

6.3.3. From Chassis to the standalone

- Connect phone to the **PHONE** jack of the standalone and the EOW of the chassis
- Use one UTP to connect the PHS jack between the EOW and the relative Multi-service Multiplexer Module
- Pick up the phone connected to the EOW
- The phone of the standalone rings, pick up and talk
- Busy sound will be sent when one hang up the phone

6.4. Maintenance

- All the Multi-service Multiplexer Modules support hot-swap function
- EOW Module also support hot-swap function, But we suggest user not to plug it when power ON for long time use
- Take care of the Optical port, avoid of any hurt from the laser
- There maybe none problem when ARL led is ON, for unused E1 can cause LOS and ARL led ON.
- Use Local/Remote button to switch the status indication between the local device and the remote device.
- Use E1 loop to test the bit error rate of the device or the transmitting line.

7. Order Information

7.1. Model

F9-480 4E1 8E1 16E1 Multi-service Multiplexer, Standalone or Module

FB-CHS FibrIDGE's Chassis

Detail order information, please refer to the below Part Number (P/N).

7.2. Part Number(P/N) of the standalone

F9-1202-XXX23	4E1 Multi-service Multiplexer, with redundant backup optical port
F9-1203-XXX23	4E1 Multi-service Multiplexer, optical port has ALS function
F9-1204-XXX23	4E1 Multi-service Multiplexer, with redundant backup optical port, and optical port has ALS function
F9-2402- XXX23	8E1 Multi-service Multiplexer, with redundant backup optical port
F9-2403- XXX23	8E1 Multi-service Multiplexer, optical port has ALS function
F9-2404- XXX23	8E1 Multi-service Multiplexer, with redundant backup optical port, and optical port has ALS function
F9-4802- XXX23	16E1 Multi-service Multiplexer, with redundant backup optical port
F9-4803- XXX23	16E1 Multi-service Multiplexer, optical port has ALS function
F9-4804- XXX23	16E1 Multi-service Multiplexer, with redundant backup optical port, and optical port has ALS function

7.3. Part Number(P/N) of the Module

F9-120-XXX23M-2	2*4E1 Multi-service Multiplexer Module
F9-1203-XXX23M-2	2*4E1 Multi-service Multiplexer Module, optical port has ALS function
F9-1202-XXX23M	4E1 Multi-service Multiplexer, with redundant backup optical port
F9-1203-XXX23M	4E1 Multi-service Multiplexer, optical port has ALS function
F9-1204-XXX23M	4E1 Multi-service Multiplexer, with redundant backup optical port, and optical port has ALS function
F9-2402- XXX23M	8E1 Multi-service Multiplexer, with redundant backup optical port
F9-2403- XXX23M	8E1 Multi-service Multiplexer, optical port has ALS function
F9-2404- XXX23M	8E1 Multi-service Multiplexer, with redundant backup optical port, and optical port has ALS function
F9-4802- XXX23M	16E1 Multi-service Multiplexer, with redundant backup optical port
F9-4803- XXX23M	16E1 Multi-service Multiplexer, optical port has ALS function
F9-4804- XXX23M	16E1 Multi-service Multiplexer, with redundant backup optical port, and optical port has ALS function

Note:

- 120ohm impedance E1 port is optional
- XXX stands for the transmit distance and optical port style. For example, 40Km, FC port, XXX will be 04F.
- Letter 23 in the above P/N means 2*10/100Mbps Ethernet port

7.4. Part Number(P/N) of the Chassis

FC-912	6U height, 14 slots, up to 12 slots for Multi-service Multiplexer Modules
FC-912-M	Management Module of the FC-912, support SNMP-based/Console/WEB management
FP-9075A	Power Module of the FC-912, 75W, 220VAC power input
FP-9120A	Power Module of the FC-912, 120W, 220VAC power input

**** We Reserve the right to vary descriptions and specifications without notice due to FibrIDGE's policy of continuous product improvement****